

Bending Beam Load Cell MP 77

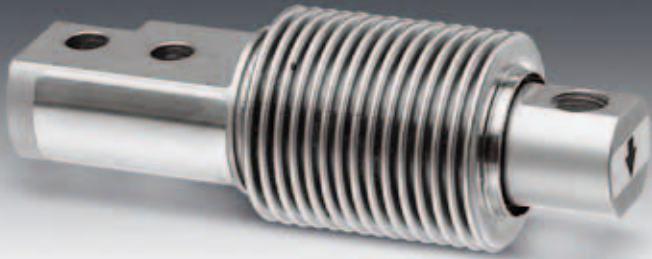

10 kg ... 500 kg

- Full stainless steel construction
- Compatible with other sources
- Hermetically welded seal (IP68)
- Approved according to OIML R60
- Ex version available

Application

- Platform scales
- Tank and hopper scales

Technical Data		C3MR	
Accuracy class (Combined error)		0.02	E_{max}
Maximum capacity	E_{max}	10 20 50 100 200 250 500	kg
Maximum usable load	E_u	200	% E_{max}
Destructive load	E_d	≥ 30	% E_{max}
Safe side load	E_{lq}	100	% E_{max}
Maximum number of LC intervals	n_{LC}	3,000	
Minimum LC verification interval $v_{min} = E_{max} Y Y$		10,000	
Rated output	C_n	2.0	mV/V
Tolerance on rated output	D_c	$< \pm 0.1$	% C_n
Zero output signal	S_{min}	$< \pm 5$	% C_n
Creep, during 30 min.	d_{cr}	$< \pm 0.016$	% C_n
Temperature effect on S_{min}	$TK_{S_{min}}$	$< \pm 0.014$	% $C_n / 10 K$
Temperature effect on C	TK_C	$< \pm 0.01$	% $C_n / 10 K$
Input impedance	R_{LC}	380 ± 10	Ω
Output impedance	R_o	350 ± 3	Ω
Insulation impedance (100 V DC)	R_{is}	≥ 5.00	M Ω
Recommended supply voltage	B_u	5 ⁰ .. 15	V
Nominal ambient temperature range	B_T	-10 ... +40	$^{\circ}C$
Usable ambient temperature range	B_{Tu}	-40 ... +80	$^{\circ}C$

Technical Data

C3MR

Nominal deflection	S_{nom}	0.29 ($E_{max} = 10$ kg); 0.30 ($E_{max} = 20$ kg); mm 0.23 ($E_{max} = 50$ kg); 0.30 ($E_{max} = 100$ kg); 0.38 ($E_{max} = 200$ kg); 0.87 ($E_{max} =$ 250 kg); 1.25 ($E_{max} = 500$ kg)
Cable length		3.0 m
Cable type		6 conductor TPE cable (AWG 26), shield grounded
Sensor material		Stainless Steel 1.4548

Protection class (acc. to IEC 529) IP68

The technical data given here serve only as a product description and must not be interpreted as guaranteed characteristics in legal sense.

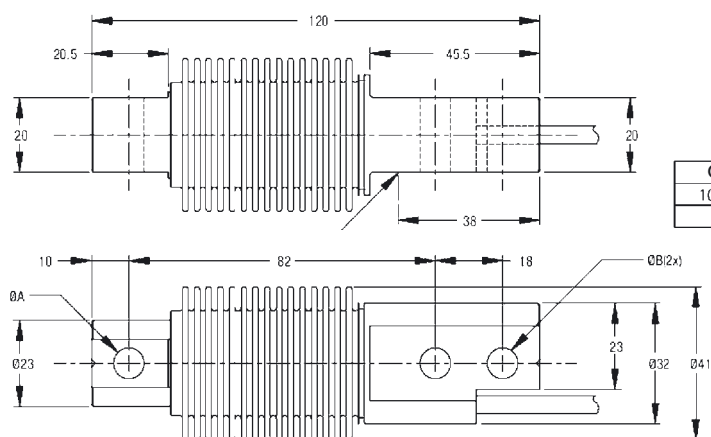

Capacity	A	B
10...250 kg	8.2	8.2
500 kg	10.5	8.2

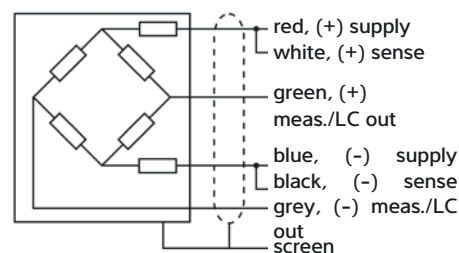

Dimensions in mm

Wiring diagram

Type	Order Number	Type	Order Number
MP 77/10kgC3MR	9408 277 07010	MP 77/10kgC3MRE	9408 677 07010
MP 77/20kgC3MR	9408 277 07020	MP 77/20kgC3MRE	9408 677 07020
MP 77/50kgC3MR	9408 277 07050	MP 77/50kgC3MRE	9408 677 07050
MP 77/100kgC3MR	9408 277 07110	MP 77/100kgC3MRE	9408 677 07110
MP 77/200kgC3MR	9408 277 07120	MP 77/200kgC3MRE	9408 677 07120
MP 77/250kgC3MR	9408 277 07125	MP 77/250kgC3MRE	9408 677 07125
MP 77/500kgC3MR	9408 277 07150	MP 77/500kgC3MRE	9408 677 07150

Certificate of conformity

MP 77 (optional)

Ex-Zone 2, 22
II 3G Ex nA II T6
II 3D Ex tD A22 IP65 T85°C

MP 77..E

Ex-Zone 0, 1, 20, 21
II 1G Ex ia IIC T6|T5 Ga
II 1D Ex ia IIIC IP67 T100°C
Da



Accessories

MP 80 | MP 90 – Cables and cable junction

boxes MP 80 Installation cable

- Temperature range: -40°C ... +90°C
- Material: TPE
- 6-wire cable

MP 90/04 Cable junction box

- Temperature range: -20°C ... +70°C
- Material: ABS
- Protection class: IP65

MP 80/31	Meteor installation cable 30 m	9408 800 80311
MP 80/51	Meteor installation cable 50 m	9408 800 80511
MP 80/12	Meteor installation cable 100 m	9408 800 80121
MP 80/32	Meteor installation cable 300 m	9408 800 80321
MP 80/80	Grounding cable	9408 800 80801
MP 90/04	Cable junction box for up to 4 load cells	9408 800 90041

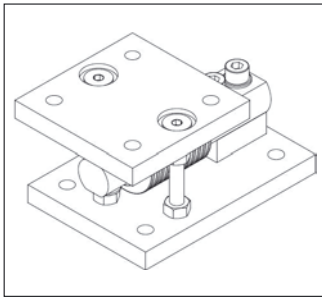

MP 97 - Mounting kit

- Simple mounting solution for tanks and hoppers
- Material: mild steel, chromated
- Permissible horizontal force:
 - MP 97/00: 2.5 KN
 - MP 97/01: 5 KN
- Dummy function: 3 KN
- Permissible lift-off force: 10 KN

MP 97/00N	Mounting kit for MP 77 up to 250 kg	9408 800 97001
MP 97/01N	Mounting kit for MP 77/500kg	9408 800 97011